



**Sukkur IBA University**  
www.iba-suk.edu.pk

## NOTICE INVITING TENDER

### Tender # PROC/383

Sukkur IBA University invites sealed bids on Single stage two envelopes procedure for item S.No. 1 to 13 and single stage one envelope procedure for item S.No. 14 to 24 from the eligible and experienced firms registered with income tax and sales tax department for following items.

| S.# | ITEMS               | S.# | ITEMS                                  |
|-----|---------------------|-----|--|
| 01  | Desktop Computers   | 14  | EE Lab Items                           |
| 02  | Server and Switches | 15  | Unmanned Aerial Vehicle Drone Device   |
| 03  | Photocopier         |     |  |
| 04  | UPSs                | 16  | Science Lab Items                      |
| 05  | Generator           | 17  | Multimedia Projectors with Accessories |
| 06  | Cisco/Equivalent AP |     |  |
| 07  | Solar System        | 18  | Electric Items                         |
| 08  | Electronics Items   | 19  | Batteries                              |
| 09  | San Storage         | 20  | Printing and Stationery                |
| 10  | SMD LED Media Wall  | 21  | Hygiene Items                          |
| 11  | Solar Panels        | 22  | Sound System                           |
| 12  | Surveillance Items  | 23  | Hybrid Inverters                       |
| 13  | Furniture & Fixture | 24  | Gas Meters                             |

#### Tender Schedule - Date and Time

|    | Issue / Sale |                          | Submission          | Opening             | Tender Fee     |
|----|--------------|--------------------------|---------------------|---------------------|----------------|
|    | From         | To                       |                     |                     |                |
| 01 | May 09, 2024 | May 28, 2024 upto 1:00pm | 28-05-2024 03:00 PM | 28-05-2024 03:30 PM | 3000 each item |

Bid Security **2%** of total quoted cost must be attached with the proposal. Tender Documents can be purchased from ADP office & shall be opened as per above schedule in same office.

Tender fee in shape of Pay order should be in favor of Sukkur IBA University. Bidding documents can be obtained and shall be submitted in the office of ADP as per above schedule. Bidders are requested to give their Best and Final Price as "No Negotiations" is permitted. Bidding Documents containing detailed terms and conditions can be downloaded from following websites & submitted along with tender document fees.

[www.iba-suk.edu.pk](http://www.iba-suk.edu.pk), [www.ppms.pprasinidh.gov.pk](http://www.ppms.pprasinidh.gov.pk)

Procuring agency reserves the right to accept or reject any or all bids prior to the acceptance of a bid as per SPP Rules 2010. (Amended to date)

In case of Government declares/announces public holiday on the date of opening of tenders, the tenders will be submitted/opened on the next working day at the same time.

**PLEASE SEND YOUR QUERIES TO: [hari@iba-suk.edu.pk](mailto:hari@iba-suk.edu.pk)**

**SUKKUR IBA UNIVERSITY**

Nisar Ahmed Siddiqui Road, Sukkur.  
Ph: 071-5644141-42 Fax: 071-5804419

ISSUED ON: \_\_\_\_\_

ISSUED TO: \_\_\_\_\_



## **BID DOCUMENTS**

### **Solar Panels**

**TENDER NO. PROC/383**

For any query / confusion related to this bid documents, please contact in writing to following:

Hari Lal Nathani  
Additional Director Procurement  
Sukkur IBA University  
Nisar Ahmed Siddiqui Road, Sukkur  
Email: hari@iba-suk.edu.pk

## LIST OF CONTENTS

|      | <b>SUBJECT</b>                                 | <b>Page No.</b> |
|------|--|-----------------|
| I    | INTRODUCTION.....                              | 3               |
| II   | SCOPE OF WORK .....                            | 4               |
| III  | OBTAINING OF BIDDING DOCUMENT .....            | 12              |
| IV   | BIDDING DATA.....                              | 10              |
| VI   | REQUIRED LIST OF DOCUMENTS.....                | 12              |
| VII  | ELIGIBILITY CRITERIA.....                      | 13              |
| VIII | TECHNICAL & FINANCIAL EVALUATION CRITERIA..... | 15              |
| IX   | PERIOD OF CONTRACT.....                        | 17              |
| X    | GENERAL CONDITIONS.....                        | 18              |
| XI   | BID FORM PRICE SCHEDULE.....                   | 21              |
| XII  | BREAKUP OF QUOTED PREMIUM.....                 | 22              |
| XIII | AGREEMENT.....                                 | 23              |

## 1. Introduction

**Sukkur IBA University invites** single-stage two envelopes tender under SPPRA Rules, 2010 (Amended to date) .

## 2. Scope of Works

As defined in the tender documents.

---

### **3. Obtaining of Bidding Document:**

- 3.1 Tender Document containing detailed terms & conditions can be obtained from the office of Additional Director Procurement, Sukkur IBA University, Nisar Ahmed Siddiqui Road, Sukkur Tel 071-564 4142 Email: [hari@iba-suk.edu.pk](mailto:hari@iba-suk.edu.pk) against non -refundable Pay Order/Demand Draft of Rs. 3,000/- being tender fee in favor of Sukkur IBA University w.e.f. date of publication of the NIT in the print media, as notified in the NIT.
- 3.2. Bidding Document can also be downloaded from the Official website of Sukkur IBA University [www.iba-suk.edu.pk](http://www.iba-suk.edu.pk) or Sindh Public Procurement Authority i.e. <http://ppms.pprasindh.gov.pk>, the bidder is required to enclose Pay order/Demand Draft of Rs.3,000/- non-refundable as a Tender Fee in favor of Sukkur IBA University.

### **4. Bidding Procedure**

- 4.1 Bids are invited as per Single Stage – Two Envelope Procedure in accordance with sub rule 2 of rule 46 of the Sindh Public Procurement Rules, 2010 (Amended to date).

### **5. Instructions to the Bidders: -**

- 5.1 Bidder must read all the contents of NIT as well as Bidding Document and understand all the requirements.
- 5.2 Bidder must ensure that the Bid Form is filled in all respect, without any confusion.
- 5.3 The Bid Form(s) shall be inserted in the Financial Proposal.
- 5.4 There should not be any over-writing, double writing, crossed, additional conditions.
- 5.5 Rates are to be quoted clearly in digits as well as in words.
- 5.6 Each document/paper submitted by the bidder shall be signed/stamped by the bidder on the face of document.
- 5.7 Bids shall be submitted in accordance with Single stage – Two Envelope Procedure.
- 5.8 Bidder shall prepare two separate envelopes for Technical as well as Financial Proposal.
- 5.9 Bidder shall examine the Bid Evaluation Criteria and insert appropriate document in the Technical/Financial Proposal accordingly.
- 5.10. Bidder(s) must write the “**TECHNICAL PROPOSAL**” and “**FINANCIAL PROPOSAL**” on the face of relevant sealed envelopes containing relevant bid/offer in it.
- 5.11. Conditional Bids, Telegraphic Bids, Bids not accompanied by Bid Security of required amount and form, bids received after specific date and time and bids of Black Listed firms shall be treated as rejected / nonresponsive.

### **List of Documents to Enclosed.**

- Bidder(s) must ensure that the following documents are enclosed with the **Technical Proposal**.
- Complete Bidding Document, duly signed and stamped on its each/every page as acceptance of all terms & conditions.
- Original Bidding Document Fees Pay Order of Rs. 3,000/- in favor of Sukkur IBA University
- Copy of Pay Order in respect of Bid Security after hiding the amount.
- Copy of NTN / Income Tax Registration Certificate, Sales Tax
- Company profile and history of the Bidder.
- List of present clients
- Annual turnover of the bidder for last three years should be equal to or twice the estimated cost of this tender item(s).
  
- Affidavit on stamp paper duly notarized to the effect that the bidder is neither blacklisted nor suspended by any National / International, including Provincial and Federal Government's department/agency/procuring agency.
- Valid documentary evidence in support of evaluation and qualification criteria.
- Bidder(s) must ensure that the following documents are enclosed with the **Financial Proposal**
- Bid Security of required amount and form.
- Bid form(s) duly filled in all respect clearly quote the price.
- Once again note that, bidder must ensure that, the Bid Form is filled in all respect, without any confusion, there should not be any over-writing, double writing, crossed, additional conditions and Rates are quoted clearly in digits as well as in words.
- **Bidder(s) must understand that all payments / transaction shall be made in Pakistani Rupees (PKR) only.**
- Bidder(s) must work carefully and quote gross rates including all applicable taxes and also incorporate the impact of Sales Tax. The SIBAU shall made payments after deduction of all applicable taxes including Income Tax & SST / GST and other taxes, if any.

## **6. Eligibility Criteria**

A bidder who meets the eligibility criteria/mandatory requirements mentioned on the Bid Data Sheet would be declared responsive for further evaluation as per the Evaluation Criteria specified in this bidding document. Verifiable documentary proof for all following requirements is a mandatory requirement; noncompliance will lead to disqualification.

6.1 Eligibility Criteria as mentioned on the Bid Data Sheet.

## **7. Language of Bids**

The bid prepared by the bidder, as well as all correspondence and documents relating to the bid exchanged by the bidder and the Procuring Agency shall be in English. Supporting documents and printed literature furnished by the bidder may be in another language provided these are accompanied by an accurate translation of the relevant passages in English, in which case for purposes of interpretation of the Bid, the translated version shall prevail.

## **8. Submission of Bids / Offer:**

Sealed bids/offers both the proposals i.e., Technical Proposal and Financial Proposal to be dropped at Procurement Section in the office of Additional Director Procurement, as notified in the NIT. However, under any circumstances, whatsoever, the sealed bids/offers shall be reached before the deadline for submission of bid. Any bid submitted / received late due to any reason whatsoever, shall not be considered at any stage and shall be returned un-opened. Any claim against the bids received late shall not be considered at any stage, hence bidders are advised to take all precautionary measures for delivery of sealed bids before the deadline for confirmed submission of bid.

**9. Opening of Bids:**

- 9.1 The Technical Proposals shall be opened within one hour of deadline for submission of offer/bid in presence of the authorized representative(s) of the bidder(s), if they wish to present at the time of opening of bids.
- 9.2 In case of the date of opening of tender declared as Public Holiday by the Government of Sindh or Federal Government or non-working day due to any reason, the next official working day shall be deemed to be the date for submission and opening of tenders/bids/offers, accordingly. The time and venue shall remain same.
- 9.3 The envelope marked Financial Proposal shall be retained unopened in the custody of SIBAU.
- 9.4 After the evaluation and approval of the technical proposal, the Financial Proposals shall be opened if technically accepted / qualified bids having the minimum qualifying points / marks of 70% or more, at a time, date and venue announced and communicated to the bidders in advance.

**10. Evaluation of Bids:**

- 10.1 Bids/Offers including Technical Proposal/Financial Proposals to be evaluated by the Procurement Committee constituted.
- 10.2 The Committee may seek the clarification from the bidder in writing or oral as the case may be, in case of committee deemed fit, however any clarification shall not be changing the sanctity of original bid;
- 10.3 The Bids/Offers shall be evaluated in accordance with the conformity of the requirements of terms & conditions of the bidding document based on the record / documentary evidence submitted by the bidder.

**10.4 Technical Proposal Evaluation**

- 10.4.1 The Bids shall be evaluated on complete Lot / Group / Package basis reflected in the Bid Form / Price Schedule. Bids for partial / limited item(s) shall not be considered and shall be rejected.
- 10.4.2 The following merit point system for weighing evaluation factors / criteria will be applied for technical proposals.
- 10.4.3 Bidders achieving **minimum 70% points / marks** will be considered only for further process besides compliance of all mandatory clauses. Documentary evidence must be attached in support of your claim.
- 12.4.3 Only those Financial Proposals will be announced / considered which were technically qualified by the Committee.



### TECHNICAL PROPOSAL EVALUATION CRITERIA

| S#                      | Evaluation Parameters/Sub-parameters   | Maximum Points |
|-------------------------|--|----------------|
| 1.                      | <b>Number of Years in the Relevant Business</b>  | Max 15         |
| 1.1                     | 15 years or above  | 15.            |
| 1.2                     | 10 years or above  | 10.            |
| 1.3                     | 7 years or above   | 05.            |
| 1.4                     | 5 years or above   | 03.            |
| 1.5                     | Below 5 years  | 01.            |
| 2.                      | <b>Total Number of Clients Universities/Corporate level</b>  | Max. 15        |
| 2.1                     | 20 and above   | 15.            |
| 2.2                     | 10-19  | 10.            |
| 2.3.                    | 5-9  | 05.            |
| 2.4.                    | Below 5  | 02.            |
| 3.                      | <b>Valid ISO Certification</b>   | Max. 10        |
| 3.1                     | Yes  | 10.            |
| 3.2                     | No.  | 00             |
| 4.                      | <b>Relevant Experience at this level</b>   | Max. 20        |
| 4.1                     | Ten or more years  | 20.            |
| 4.2                     | Five to nine Years   | 10.            |
| 4.3                     | One to five years  | 05             |
| 5.                      | <b>Business Relationship with Original Equipment Manufacturer</b>  | Max. 15        |
| 5.1                     | Authorized Distributor   | 15.            |
| 5.2                     | Authorized Dealer  | 10             |
| 6                       | <b>Company Profile</b>   | Max. 15        |
| 6.1                     | Public /Private Limited Company  | 15             |
| 6.2                     | Partnership  | 10             |
| 6.3                     | Sole Proprietorship  | 5              |
| 7                       | <b>Satisfactory Feedback from Existing Clients</b>   | Max. 10        |
| 7.1                     | More than 10 clients   | 10             |
| 7.2                     | 5 to 9 clients   | 5              |
| 7.3                     | Less than 5 clients  | 3              |
| <b>Total Points</b>     |  | <b>100</b>     |
| <b>Important Notes:</b> | <b>Please attach documentary evidence in support of your claims against technical evaluation criteria in the technical proposal. To technically qualify, the bidder must achieve a minimum score of 70 out of 100.</b> |                |

## **10.5 Financial Proposal Evaluation**

- 10.5.1 Technically qualified/successful bidder(s)/Tenderer(s) shall be eligible for Financial Proposal(s). The Financial bids shall be opened in the presence of the Bidders at the scheduled date, time and venue communicated in advance or as defined in this document.
- 10.5.2 Financial Bids/Financial Proposals of Technically disqualified / rejected bidders will not be opened and sealed envelopes shall be returned to the bidder.
- 10.5.3 Bids not accompanied by the Bid Security of required amount and form shall be rejected.
- 10.5.4 Procuring Agency shall not be responsible for any erroneous calculation of taxes and all differences arising out shall be fully borne by the Successful Bidder. However, any subsequent changes in rates or structure of applicable taxes by the Government at any time during execution / evaluation period shall be passed to the Procuring Agency.

## **11. Announcement of Bid Evaluation Report**

- 11.1 Bids/Offeres including Technical Proposal/Financial Proposals to be evaluated by the Committee constituted by the SIBAU for the purpose.
- 11.2 The Bid Evaluation Report shall be announced and shall be hoisted on websites of the Authority and Procuring Agency.

## **12. Award of Contract:**

- 12.1 The bidder whose offered rate is found most advantageous amongst other technically qualified bidders shall be considered for acceptance of the offer provided that if it fulfills the laid down terms and conditions of the tender, irrespective of their score in the previous step.
- 12.2 In case of tie among two or more bidders in financial bid with identical offered rate, the contract shall be awarded to the bidder who shall obtain the highest points / marks in technical evaluation report.
- 12.3 SIBAU reserve rights to cancel any/all bids, subject to the relevant provisions of SPP Rules 2010 (Amended to-date).

## **13. Signing of Contract:**

In case of award, the Insurance Company shall sign the contract on appropriate stamp paper. All charges including payment of stamp duty shall be borne by the Insurance Company.

**14. Period of Contract.**

The contract shall be made for a period of two years (24 months). However, It can mutually be extended for two years (if required) with the terms and conditions mentioned in clause # 1.

**15. Bid Security / Performance Guarantee:**

15.1 The Bidder shall enclose the Bid Security not less than 2% of the total contract value of the two years (24 months) in the shape of Deposit at Call or Pay Order or Demand Draft or a Bank Guarantee in favor of Sukkur IBA University issued by a scheduled bank in Pakistan valid for a period of 28 days beyond the bid validity period. The Bid Security shall be attached with the Financial Proposal.

15.2 The Bid Security of unsuccessful bidder shall be returned after award of contract or within one week of expiry of bid.

15.3 The Successful bidder shall submit the Performance Security / Guarantee equal to 2% of the total contract value of the two years (24 months) in the shape of Call Deposit or Pay Order or Demand Draft or a Bank Guarantee in favor of Sukkur IBA University issued by a scheduled bank in Pakistan valid for a period of ninety (90) days beyond the date of completion / expiry of the contract. The bid security of successful bidder may be retained as performance security.

15.4 The Bid Security of successful bidder shall be returned after receipt of Performance Security / Guarantee. However, the successful bidder can adjust the Bid Security towards Performance Guarantee, in this situation, the successful bidder shall submit the balance amount on account of Performance Guarantee.

15.5 The Performance Security / Guarantee shall be forfeited, in case company fails to provide the satisfactory services. The Performance Security / Guarantee shall be returned after expiry of contract and settlement of all claims by the company.

**16. Delivery Time/ Project Completion Time:**

16.1 Please clearly mention the project completion time with milestones wise.

**17. Warranty/Guarantee:**

- 17.1 Please clearly mention the warranty/guarantee period starting from the date of satisfactory completion of the project.

**18. General Conditions:**

- 18.1 A prospective company requiring any clarification(s) may inform to SIBAU or an Officer authorized on its behalf in writing. The SIBAU or concerned Officer authorized on its behalf will respond to any request for clarification which is received well before 05 working days or more to the deadline set for the submission of bids. Any clarification required by any bidder that may be of importance of other bidders or any clarification deemed to be made by the university will be uploaded on the Sukkur IBA University website's tender page where tender documents are uploaded.
- 18.2 Bidder shall comply with all Pakistani Laws, permits, codes and regulation applicable to the bidder's performance of services. Bids against the Government Rules and Policy, Conditional Bids, Telegraphic Bids, Bids not accompanied by Bid Security of required amount and form, bids received after specific date and time and bids of Black Listed firms will not be considered and will be rejected.
- 18.3 The SIBAU reserves the right to increase/decrease/delete the number of items.

**19. Payment**

- 19.1 Payment of shall be processed as follows:
- 19.2 The vendor shall submit the following documents along with the Invoice:
- 19.2.1 Original Invoice in triplicate.
- 19.2.2 Copy of the Signed Contract.

**20. Cancellation of Contract:**

If the vendor fails to provide satisfactory services, items etc. the Sukkur IBA University shall be entitled at its option to cancel the contract and recover the damages besides forfeiture of the Performance Guarantee. The Sukkur IBA University shall not be liable to any risks and costs whatsoever in consequence of such cancellation of the contract.

**21. Arbitration:**

21.1 Any difference or dispute or liability of whatsoever nature arising out of the contract or in any way relating to the contract or to its construction or fulfillment should be settled as far as possible, amicably between the SIBAU and vendor. Should the parties fail to come to an amicable settlement the same shall be referred to the award of Arbitrators to be nominated one each by the SIBAU and vendor within fifteen (15) days of notice from either side or in the case of the said Arbitrators not agreeing, then to the award of an Umpire to be appointed by the Arbitrators in writing prior to proceeding with the arbitration. The decision of the Arbitrators or the Umpire, as the case may be, shall be final and binding on both parties. The arbitration shall take place at Sukkur, under Pakistani Law of Arbitration.

22.2 Subject to the above, should any recourse to Courts of Law become necessary, the parties hereto submit to the jurisdiction of the Courts of law at Sukkur, Pakistan which courts shall have exclusive jurisdiction to settle any claims and/or dispute arising out of this Agreement or any acts done in pursuance thereof regardless of the location or place of business of parties hereto. However, CLIENT may at its own option also proceed against Vendor in the court of law for any claims it may have.

## BID FORM / PRICE SCHEDULE

(To be submitted on Official Company Letterhead Duly Signed & Stamp)

| S# | Descriptions | (Amount ONLY in PKR) |
|----|--------------|----------------------|
| 1. |              |                      |

Signature: \_\_\_\_\_

Name: \_\_\_\_\_

CNIC \_\_\_\_\_

Designation \_\_\_\_\_

Company \_\_\_\_\_

Stamp \_\_\_\_\_

Dated \_\_\_\_\_

**PART-II**  
**INSTRUCTION TO BIDDERS**

- i Source of Funds** Funds would be arranged from a funded project. The eligible payment under the contract is to be made from recurring budget
- ii Eligible Bidders**
- ii.a This Invitation for Bids is open to all suppliers from eligible source as defined in the SPP Rules, 2010 (amended to date) and its Bidding Documents except as provided hereinafter.
- ii.b Bidders should not be associated, or have been associated in the past, directly or indirectly, with a firm or any of its affiliates which have been engaged by the Procuring agency to provide consulting services for the preparation of the design, specifications, and other documents to be used for the procurement of the goods to be purchased under this Invitation for Bids.
- ii.c Government-owned enterprises in the Province of Sindh may participate only if they are legally and financially autonomous, if they operate under commercial law, and if they are not a dependent agency of the Government of Sindh.
- ii.d Bidders shall not be eligible to bid if they are under a declaration of ineligibility for corrupt and fraudulent practices issued by the any government organization.
- iii Eligible Goods and Services**
- iii.a The origin of all the goods & related services to be supplied under the Contract should be mentioned.
- iii.b Origin means the place where the goods are mint, grown or produce or the place from which the related services are supplied.
- iii.c The Origin of goods and services is distinct from the nationality of bidders.
- iv Cost of Bidding**
- iv.a The Bidder shall bear all costs associated with the preparation and submission of its bid, and the Procuring agency named in the Bid Data Sheet, hereinafter referred to as “the Procuring agency,” will in no case be responsible or liable for those costs, regardless of the conduct or outcome of the bidding process.

## **B. The Bidding Documents**

- v Content of Bidding Documents**
- v.a The bidding documents include:
- (a) Instructions to Bidders (ITB)
  - (b) Bid Data Sheet
  - (c) General Conditions of Contract (GCC)
  - (d) Special Conditions of Contract (SCC)
  - (e) Schedule of Requirements
  - (f) Technical Specifications
  - (g) Bid Form and Price Schedules
  - (h) Bid Security Form
  - (i) Contract Form
  - (j) Performance Security Form
  - (k) Manufacturer's Authorization Form
- v.b The Bidder is expected to examine all instructions, forms, terms, and specifications in the bidding documents. Failure to furnish all information required by the bidding documents or to submit a bid not substantially responsive to the bidding documents in every respect will be at the Bidder's risk and may result in the rejection of its bid.
- vi Clarification of Bidding Documents**
- vi.a A interested Bidder requiring any clarification of the bidding documents may notify the Procuring agency in writing. The Procuring agency will respond in writing to any request for clarification of the bidding documents which it receives no later than three working days prior to the deadline for the submission of bids prescribed in the Bid Data Sheet. Written copies of the Procuring agency's response (including an explanation of the query but without identifying the source of inquiry) will be sent to all interested bidders that have received the bidding documents.
- vii Amendment of Bidding Documents**
- vii.a At any time prior to the deadline for submission of bids, the Procuring agency, for any reason, whether at its own initiative or in response to a clarification requested by a interested Bidder, may modify the bidding documents by amendment.
- vii.b All interested bidders that have received the bidding documents will be notified of the amendment in writing, and will be binding on them.
- vii.c In order to allow interested bidders reasonable time in which to take the amendment into account in preparing their bids, the Procuring agency, at its discretion, may extend the deadline for the submission of bids.



### **C. Preparation of Bids**

- 1. Scope**
  - 1.1 Sukkur IBA University intends the subject procurement through National Competitive Bidding Single Stage Two Envelopes Procedure as per SPPRA Rules-2010(Amended up to date).
  
- 2. Language of Bid**
  - 2.1 The bid prepared by the Bidder, as well as all correspondence and documents relating to the bid exchanged by the Bidder and the Procuring agency shall be written in the English language.
  
- 3. Documents Comprising the Bid**
  - 3.1 The bid prepared by the Bidder shall comprise the following components:
    - a) Price Schedule completed in accordance with ITB Clauses 4, 5 and 6.
    - b) bid security furnished in accordance with ITB Clause-9.
  
- 4. Bid Prices**
  - 4.1 The Bidder shall indicate on the appropriate Price Schedule the unit prices (where applicable) and total bid price of the goods it proposes to supply under the contract.
  
  - 4.2 The prices shall be quoted on delivery to consignee's end inclusive of all taxes, stamps, duties, levies, fees and installation and integration charges imposed till the delivery location specified in the schedule of Requirements. No separate payment shall be made of the incidental services.
  
  - 4.3 Prices quoted by the by the Bidder shall be fixed during the Bidder's performance of the contract and not subject to variation on any account, unless otherwise specified in the Bid Data Sheet.
  
  - 4.4 Prices shall be quoted in Pak Rupees unless otherwise specified in the Bid Data Sheet.
  
- 5. Bid Form**
  - 5.1 The Bidder shall complete the Bid Form and the appropriate Price Schedule furnished in the bidding documents, indicating the goods to be supplied, a brief description of the goods, their country of origin, quantity, and prices.
  
- 6. Bid Currencies**
  - 6.1 Prices Shall be quoted in Pak Rupees.
  
- 7. Bidder's Eligibility**
  - 7.1 As defined in Bid Data Sheet.

- 8. Documents Establishing Goods' Eligibility and Conformity to Bidding Documents**
- 8.1 The documents evidence of conformity of the goods and services to the bidding documents may be in the form of literature, drawings, and Data, and shall consist of:
- (a) a detailed description of the essential technical and performance characteristics of the goods;
  - (b) the Bidder shall note that standards for workmanship, material, and equipment, as well as references to brand names or catalogue numbers designated by the Procuring agency in its Technical Specification are intended to be descriptive only and not restrictive: till stated otherwise in Technical Specifications or Bid Data Sheet. The Bidder may substitute alternative standards, brand names, and /Or catalogue numbers in its bid, provided that demonstrates to the Procuring agency's satisfaction that the substitutions ensure substantial equivalence to those designated in the in the Technical Specifications
- 9. Bid Security**
- 9.1 The bid security is required (in the amount specified in the bid data sheet) to protect the Procuring agency against the risk of Bidder's conduct, which would warrant the security's forfeiture. The bid security shall be denominated in the currency of the bid:
- a) at the Bidder's option, be in the form of either demand draft/call deposit or an unconditional bank guarantee from a reputable Bank;
  - b) be submitted in its original form: copies will not be accepted;
  - c) remain valid for a period of at least 14 days beyond the original validity period of bids, or at least 14 days beyond any extended period of bid validity.
- 9.2 bid security shall be released to the unsuccessful bidders once the contract has been signed with the successful bidder or the validity period has expired.
- 9.3 The successful Bidder's bid security shall be discharged upon the Bidder signing the contract, and furnishing the performance security.
- 9.4 The bid security may be forfeited:
- a) if a Bidder withdraws its bid during the period of bid validity or
  - b) in the case of a successful Bidder, if the bidder fails:
    - (i) to sign the contract in accordance or
    - (ii) to furnish performance security

- |                                       |  |
|---------------------------------------|--|
| <b>10. Period of Validity of Bids</b> | <p>10.1 Bids shall remain valid for the period specified in the Bid Data Sheet after the date of bid opening prescribed by the Procuring agency. A bid valid for a shorter period shall be rejected by the Procuring agency as non-responsive.</p> <p>10.2 In exceptional circumstances, the Procuring agency may solicit the Bidder's consent to an extension of the period of validity. The request and the responses thereto shall be made in writing. The bid security shall also be suitable extended. A Bidder may refuse the request without forfeiting its bid security. A Bidder granting the request will not be required not be required nor permitted to modify its bid.</p> |
| <b>11. Format and Signing of Bid</b>  | <p>11.1 The Bidder shall prepare an original bid indicated in the Bid Data Sheet, clearly marking each "ORIGINAL BID" as appropriate. In the event of any discrepancy between them, the original shall govern.</p> <p>11.2 The original bid shall be signed by the Bidder or a person or persons duly authorized to bind the Bidder to the contract.</p> <p>11.3 Any interlineations, erasures, or overwriting shall be valid only if they are initialed by the person or persons signing the bid.</p>   |

**D. Submission of Bids**

- |  |   |
|--|---|
| <b>12. Sealing and Marking of Bids</b>     | <p>12.1 The Bidder shall seal the original bid in envelope, duly marking the envelope as "ORIGINAL BID". The envelope shall then be sealed in an outer envelope. The inner and outer envelopes shall be addressed to the Procuring agency at the address given in the BDS, and carry statement <b><u>"DO NOT OPEN BEFORE<br/>at A.M"</u></b></p> <p>12.2 If the outer envelope is not sealed and marked as required, the Procuring agency shall assume no responsibility for the bid's misplacement or premature opening.</p> |
| <b>13. Deadline for Submission of Bids</b> | <p>13.1 Bids must be received by the Procuring agency at the address specified in Bid Data Sheet, not later than the time and date specified in Bid Data Sheet.</p> <p>13.2 The Procuring agency may, at its discretion, extend this deadline for the submission of bids by amending the bidding documents, in such case all rights and obligations of the Procuring agency and bidders previously subject to the deadline will thereafter be subject to the deadline.</p>  |
| <b>14. Late Bids</b>                       | <p>14.1 Any bid received by the Procuring agency after the deadline for submission of bids prescribed by the Procuring agency shall be rejected and returned unopened to the Bidder.</p>  |

- 
- 15. Modification and Withdrawal of Bids**
- 15.1 The Bidder may modify or withdraw its bid after the bid's submission, provided that written notice of the modification, including substitution or withdrawal of the bids, is received by the Procuring agency prior to the deadline prescribed for submission of bids.
- 15.2 No bid may be modified after the deadline for submission of bids.
- 15.3 No bid may be withdrawn in the interval between the deadline for submission of bids and the expiry of the period of bid validity withdrawal of a bid during this interval may result in the Bidder's forfeiture of its bid security.

#### **E. Opening and Evaluation of Bids**

- 16. Opening of Bids by the Procuring agency**
- 16.1 The Procuring agency shall open all bids in the presence of bidder's representatives who choose to attend, at the time, on the date, and at the place specified in the Bid Data Sheet. The bidders' representatives who are present shall sign a register/attendance sheet evidencing their attendance.
- 16.2 The bidders' names, bid modifications or withdrawals, bid prices, discounts, and the presences or absence of requisite bid security and such other details as the Procuring agency, at its discretion, may consider appropriate, will be announced at the opening.
- 17. Clarification of Bids**
- 17.1 During evaluation of the bids, the Procuring agency may, at its discretion, ask the Bidder for a clarification of its bid. The request for clarification and the response shall be in writing, and no change in the prices or substance of the bid shall be sought, offered, or permitted.
- 18. Preliminary Examination**
- 18.1 The Procuring agency shall examine the bids to determine whether they are complete, whether any computational errors have been made, whether required sureties have been furnished, whether the documents have been properly signed, and whether the bids are generally in order.
- 18.2 Arithmetical errors will be rectified on the following basis. If there is a discrepancy between the unit price and the total price that is obtained by multiplying the unit price and quantity, the unit price shall prevail, and the correction of the errors, its bid will be rejected, and its bid security may be forfeited. If there is a discrepancy between words and figures, the amount in words will prevail.

- 
- 18.3 Prior to the detailed evaluation, the Procuring agency will determine the substantially responsive bid is one which conforms to all the terms and conditions of the bidding documents without material deviations. Procuring agency's determination of a bid's responsiveness is to be based on the contents of the bid itself.
- 18.4 If a bid is not substantially responsive, it will be rejected by the Procuring agency and may not subsequently be made responsive by the Bidder by correction of the nonconformity.
- 19. Evaluation and Comparison of Bids**
- 19.1 The Procuring agency will evaluate and compare the bids which have been determined to be substantially responsive.
- 19.2 The Procuring agency's evaluation of a bid will be on delivery to consignee's end inclusive of all taxes, stamps, duties, levies, fees and installation and integration charges imposed till the delivery location and shall exclude any allowance for price adjustment during the period of execution of the contract.
- 20. Contacting the procuring agency**
- 20.1 No Bidder shall contact the procuring agency on any matter relating to its bid, from the time of bid opening to the time the announcement of Bid Evaluation Report. If the Bidder wishes to bring additional information to the notice of the procuring agency, it should do so in writing.
- 20.2 Any effort by a Bidder to influence the Procuring agency in its decision on bid evaluation, bid comparison, or contract award may result in the rejection of the Bidder's bid.

## Award of contract

- 21. Post – Qualification**
- 21.1 In the absence of prequalification, the procuring agency may determine to its satisfaction whether that selected Bidder having submitted the lowest evaluation responsive bid is qualified to perform the contract satisfactorily.
- 21.2 The determination will take into account the Bidder’s financial, technical, and production capabilities. It will be based upon an examination of the documentary evidence of the Bidder’s qualifications submitted by the Bidder, pursuant to ITB Claus-7 as well as such other information as the Procuring agency deems necessary and appropriate.
- 21.3 An affirmative determination will be a prerequisite for award of the contract to the Bidder. A negative determination will result in rejection of the Bidder’s bid, in which event the Procuring agency will proceed to the next lowest evaluated bid to perform satisfactorily.
- 22. Award Criteria**
- 22.1 The Procuring agency will award the contract to the successful Bidder whose bid has been determined to be substantially responsive and has been determined to be the lowest evaluated bid, provided further that the Bidder is determined to be qualified to perform the contract satisfactorily.
- 22 a Procuring Agency’s right to vary quantities at the time of award**
- The Procuring Agency reserves the right to increase/decrease the quantity of the required items and /or purchase part items already tendered either in full or in part. The Procuring Agency reserves the right to accept or reject any or all of the Tenders; divide business amongst more than one bidder.
- 23. Procuring agency’s Right to Accept any Bid and to Reject any or All Bids**
- 23.1 Subject to relevant provisions of SPP Rules 2010 (Amended to date), the Procuring agency reserves the right to accept or reject any bid, and to annul the bidding process and reject all bids at any time prior to contract award.
- 23.2 Pursuant to Rule 45 of SPP Rules 2010 (Amended to date), Procuring agency shall hoist the evaluation report on Authority’s web site, and intimate to all the bidders three working days prior to notifythe award of contract.
- 24. Notification of Award**
- 24.1 Prior to the expiration of the period of bid validity, the Procuring agency shall notify the successful Bidder in writing, that its bid has been accepted.

- 
- 24.2 Upon the successful Bidder's furnishing of the performance security pursuant to ITB Clause 26, the Procuring agency will promptly notify each unsuccessful Bidder and will discharge its bid security.
- 25. Signing of Contract**
- 25.1 At the same time as the Procuring agency notifies the successful Bidder that its bid has been accepted, the Procuring agency will send the Bidder the Contract Form provided in the bidding documents, incorporating all agreements between the parties.
- 25.2 Within fourteen (14) days, or any other period specified in BDS, of receipt of the Contract Form, the successful Bidder shall sign and date the contract and return it to the Procuring agency.
- 25.3 For enhancement of quality and efficiency terms & conditions of tender can be reviewed with the mutual consent between successful bidder(s) and Procuring Agency.
- 26. Performance Security**
- 26.1 Within seven (07) days, or any other period specified in BDS, of the receipt of notification of award from the Procuring agency, the successful Bidder shall furnish the performance security in accordance with the Conditions of Contract, in the Performance Security Form provided in the bidding documents, or in another form acceptable to the Procuring agency.
- 26.2 Failure of the successful Bidder to comply with the requirement of ITB Clause 25 or ITB Clause 26.1 shall constitute sufficient grounds for the annulment of the award and forfeiture of the bid security, in which event the Procuring agency may make the award to the next lowest evaluated Bidder or call for new bids.
- 27. Corrupt or Fraudulent Practices**
- 27.1 The Government of Sindh requires that Procuring agency's (including beneficiaries of donor agencies' loans), as well as Bidders/Suppliers/Contractors under Government-financed contracts, observe the highest standard of ethics during the procurement and execution of such contracts. In pursuance of this policy, the SPPRA, in accordance with the SPP Act, 2009 and Rules made there under:
- (a) **“Corrupt and Fraudulent Practices”** means either one or any combination of the practices given below;
- (i) **“Coercive Practice”** means any impairing or harming, or threatening to impair or harm, directly or indirectly, any party or the property of the party to influence the actions of a party to achieve a wrongful gain or to cause a wrongful loss to another party;

(ii) **“Collusive Practice”** means any arrangement between two or more parties to the procurement process or contract execution, designed to achieve with or without the knowledge of the procuring agency to establish prices at artificial, noncompetitive levels for any wrongful gain;

(iii) **“Corrupt Practice”** means the offering, giving, receiving or soliciting, directly or indirectly, of anything of value to influence the acts of another party for wrongful gain;

(iv) **“Fraudulent Practice”** means any act or omission, including a misrepresentation, that knowingly or recklessly misleads, or attempts to mislead, a party to obtain a financial or other benefit or to avoid an obligation;

b) **“Obstructive Practice”** means harming or threatening to harm, directly or indirectly, persons or their property to influence their participation in a procurement process, or affect the execution of a contract or deliberately destroying, falsifying, altering or concealing of evidence material to the investigation or making false statements before investigators in order to materially impede an investigation into allegations of a corrupt, fraudulent, coercive or collusive practice; or threatening, harassing or intimidating any party to prevent it from disclosing its knowledge of matters relevant to the investigation or from pursuing the investigation, or acts intended to materially impede the exercise of inspection and audit rights provided for under the Rules.



**Part-III**  
**General Conditions of Contract**

**1. Definitions**

- 1.1 In this Contract, the following terms shall be interpreted as indicated:
- (a) **“The Contract”** means the agreement entered into between the Procuring agency and the Supplier, as recorded in the Contract Form signed by the parties, including all attachments and appendices thereto and all documents incorporated by reference therein.
  - (b) **“The Contract Price”** means the price payable to the Supplier under the Contract for the full and proper performance of its contractual obligations.
  - (c) **“The Goods”** means all of the equipment, machinery, and/or other materials, which the Supplier is required to supply to the Procuring agency under the Contract.
  - (d) **“The Services”** means those services ancillary to the supply of the Goods, such as transportation and insurance, and any other incidental services, such as installation, commissioning, provision of technical assistance, training, and other such obligations of the Supplier covered under the Contract.
  - (e) **“GCC”** mean the General Conditions of Contract contained in this section.
  - (f) **“SCC”** means the Special Conditions of Contract.
  - (g) **“The Procuring agency”** means Sukkur IBA University
  - (h) **“The Supplier”** means the individual or firm supplying the Goods and Services under this Contract.
  - (i) **“SPP Rules 2010”** means the Sindh Public Procurement Rules 2010 (Amended to date).
  - (j) **“Day”** means calendar day.

- 2. Standards** The Goods supplied under this Contract shall conform to the standards mentioned in the Technical Specifications, and, when no applicable standard is mentioned, to the authoritative standards appropriate to the goods' country of origin. Such standards shall be the latest issued by the concerned institution.
- 3. Patent Rights** The Supplier shall indemnify the Procuring agency against all third- party claims of infringement of patent, trademark, or industrial design rights arising from use of the Goods or any part thereof in the Islamic Republic of Pakistan.
- 4. Performance Security**
- 4.1 Within seven (07) days, or any other duration as specified in SCC, of receipt of the notification of Contract award, the successful Bidder shall furnish to the Procuring agency the performance security in the amount specified in SCC.
- 4.2 The proceeds of the performance security shall be payable to the Procuring agency as compensation for any loss resulting from the Supplier's failure to complete its obligations under the Contract.
- 4.3 The performance security shall be denominated in the Pak rupees and shall be an unconditional bank guarantee, pay order, call deposit as, provided in the bidding documents or another form acceptable to the Procuring agency;
- 4.4 The performance security will be discharged by the Procuring agency and returned to the Supplier not later than thirty (30) days following the date of completion of the Supplier's performance obligations under the Contract, including any warranty obligations, unless specified otherwise in SCC.
- 5 Inspections and Tests**
- 5.1 The Procuring agency or its representative shall have the right to inspect and/or to test the Goods to confirm their conformity to the Contract specifications at no extra cost to the Procuring agency. The Procuring agency shall notify the Supplier in writing, in a timely manner, of the identity of any representatives retained for these purposes.
- 5.2 Should any inspected or tested Goods fail to conform to the Specifications, the Procuring agency may reject the Goods, and the Supplier shall either replace the rejected Goods or make alterations necessary to meet specification requirements free of cost to the Procuring agency.
- 5.4 The Procuring agency's right to inspect, test and, where necessary, reject the Goods after the Goods' arrival shall in no way be limited or waived by reason of the Goods having previously been inspected, tested, and passed by the Manufacturer.

5.5 Nothing in GCC Clause 5 shall in any way release the Supplier from any warranty or other obligations under this Contract.

**6. Packing**

The Supplier shall provide such packing of the Goods as is required to prevent their damage or deterioration during transit to their final destination. The packing shall be sufficient to withstand, without limitation, rough handling during transit and exposure to extreme temperatures, salt and precipitation during transit, and open storage.

**7. Delivery and Documents**

Delivery of the Goods shall be made by the Supplier in accordance with the terms specified in the Schedule of Requirements. The details of shipping/ transportation and/or other documents to be furnished by the Supplier are specified in SCC.

**8. Insurance**

No need of Insurance for Local Supplies, However Supplier is responsible to deliver the goods in perfect condition to the end user.

**9. Transportation**

The Supplier is required under the Contract to transport the Goods to a specified place of destination and shall be arranged by the Supplier, and related costs shall be deemed to have been included in the Contract Price.

**10. Incidental Services**

10.1 The Supplier may be required to provide any or all of the following services, including additional services, if any, specified in SCC:

- (a) performance or supervision of on-site assembly and/or start-up of the supplied Goods;
- (b) furnishing of tools required for assembly and/or maintenance of the supplied Goods;
- (c) furnishing of a detailed operations and maintenance manual for each appropriate unit of the supplied Goods;
- (d) performance or supervision or maintenance and/or repair of the supplied Goods, for a period of time agreed by the parties, provided that this service shall not relieve the Supplier of any warranty obligations under this Contract; and

**11. Spare Parts**

11.1 The Supplier should provide any or all of the notifications, and information pertaining to spare parts manufactured or distributed by the Supplier:

- (a) such spare parts as the Procuring agency may elect to purchase from the Supplier, provided that this election shall not relieve the Supplier of any warranty obligations under the Contract; and

- (b) in the event of termination of production of the spare parts:
  - (i) advance notification to the Procuring agency of the pending termination, in sufficient time to permit the Procuring agency to procure needed requirements; and
  - (ii) following such termination, furnishing at no cost to the Procuring agency, the blueprints, drawings, and specifications of the spare parts, if requested.

## **12. Warranty**

- 12.1 The Supplier warrants that the Goods supplied under the Contract are new, unused, of desired models, and that they incorporate all recent improvements in design and materials unless provided otherwise in the Contract. The Supplier further warrants that all Goods supplied under this Contract shall have no defect, arising from design, materials, or workmanship (except when the design and/or material is required by the Procuring agency's specifications) or from any act or omission of the Supplier, that may develop under normal use of the supplied Goods in the conditions prevailing in the country of final destination.
- 12.2 This warranty / maintenance period shall remain valid for One (01) Year after the Goods, or any portion thereof as the case may be, have been delivered to and accepted at the final destination indicated in the Contract
- 12.3 If the Supplier, having been notified, fails to remedy the defect(s) within the period specified in SCC, within a reasonable period, the Procuring agency may proceed to take such remedial action as may be necessary, at the Supplier's risk and expense and without prejudice to any other rights which the Procuring agency may have against the Supplier under the Contract.

## **13. Payment**

- 13.1 The firm should submit stamp duty as per Government Rule before execution of work.
- 13.2 Within 30 days after the issuance of inspection certificate and consignee's receipt certificate as mentioned in SSC clause 6.
- 13.3 If the supply is not according to the specifications or unsatisfactory, the Contract will be rejected and cancelled at the risk and cost of Firm
- 13.4 If the firm fails to execute the contract/supply order as per condition, action will be taken against them which may be their black listing and Earnest Money. / Security Deposit will be forfeited.

13.5 In case of late delivery @ 0.1% per day will be charged on bid amount deducted from the bill, but not more than 10% of contract value.

13.6 The currency of payment is Pak. Rupees.

**14. Prices**

Prices charged by the Supplier for Goods delivered and Services performed under the Contract shall not vary from the prices quoted by the Supplier in its bid,

**15. Contract Amendments**

No variation in or modification of the terms of the Contract shall be made except by written amendment signed by the parties.

**16. Delays in the Supplier's Performance**

16.1 Delivery of the Goods and performance of Services shall be made by the Supplier in accordance with the time schedule prescribed by the Procuring agency in the Schedule of Requirements.

16.2 If at any time during performance of the Contract, the Supplier or its subcontractor(s) should encounter conditions obstructing timely delivery of the Goods and performance of Services, the Supplier shall promptly notify the Procuring agency in writing of the fact of the delay, its likely duration and its cause(s). As soon as practicable after receipt of the Supplier's notice, the Procuring agency shall evaluate the situation and may at its discretion extend the Supplier's time for performance, with or without liquidated damages, in which case the extension shall be ratified by the parties by amendment of Contract.

16.3 Except as provided under GCC Clause 19 a delay by the Supplier in the performance of its delivery obligations shall render the Supplier liable to the imposition of liquidated damages pursuant to GCC Clause 17 unless an extension of time is agreed upon pursuant to GCC Clause 16.2 without the application of liquidated damages.

**17. Liquidated Damages**

Subject to GCC Clause 19, if the Supplier fails to deliver any or all of the Goods or to perform the Services within the period(s) specified in the Contract, the Procuring agency shall, without prejudice to its other remedies under the Contract, deduct from the Contract Price, as liquidated damages, a sum equivalent to the percentage specified in SCC of the delivered price of the delayed Goods or unperformed Services for each week or part thereof of delay until actual delivery or performance, up to a maximum deduction of the percentage specified in SCC. Once the maximum is reached, the Procuring agency may consider termination of the Contract pursuant to GCC Clause 18.

**18. Termination for Default**

18.1 The Procuring agency, without prejudice to any other remedy for breach of Contract, by written notice of default sent to the Supplier, may terminate this Contract in whole or in part:

- (a) if the Supplier fails to deliver any or all of the Goods within the period(s) specified in the Contract, or within any extension thereof granted by the Procuring agency pursuant to GCC Clause 16; or
- (b) If the Supplier fails to perform any other obligation(s) under the Contract.
- (c) If the Supplier, in the judgment of the Procuring agency has engaged in corrupt or fraudulent practices in competing for or in executing the Contract.

18.2 In the event the Procuring agency terminates the Contract in whole or in part, pursuant to GCC Clause 18.1, the Procuring agency may procure, upon such terms and in such manner as it deems appropriate, Goods or Services similar to those undelivered, and supplier shall be liable to the Procuring agency for any excess costs for such similar Goods or services. However, the Supplier shall continue performance of the Contract to the extent not terminated.

**19. Force Majeure**

19.1 Notwithstanding the provisions of GCC Clauses 16, 17 and 18, the Supplier shall not be liable for forfeiture of its performance security, liquidated damages, or termination for default if and to the extent that its delay in performance or other failure to perform its obligations under the Contract is the result of an event of Force Majeure.

19.2 For purposes of this clause, "Force Majeure" means an event beyond the control of the Supplier and not involving the Supplier's fault or negligence and not foreseeable. Such events may include, but are not restricted to, acts of the Procuring agency in its sovereign capacity, wars or revolutions, fires, floods, epidemics, quarantine restrictions, and freight embargoes.

- 19.3 If a Force Majeure situation arises, the Supplier shall promptly notify the Procuring agency in writing of such condition and the cause thereof. Unless otherwise directed by the Procuring agency in writing, the Supplier shall continue to perform its obligations under the Contract as far as is reasonably practical, and shall seek all reasonable alternative means for performance not prevented by the Force Majeure event.
- 20. Termination for Insolvency** 20.1 The Procuring agency may at any time terminate the Contract by giving written notice to the Supplier if the Supplier becomes bankrupt or otherwise insolvent. In this event, termination will be without compensation to the Supplier, provided that such termination will not prejudice or affect any right of action or remedy which has accrued or will accrue thereafter to the procuring agency.
- 21. Termination for Convenience** 21.1 The Procuring agency, by written notice sent to the Supplier, may terminate the Contract, in whole or in part, at any time for its convenience. The notice of termination shall specify that termination is for the Procuring agency's convenience, the extent to which performance of the Supplier under the Contract is terminated, and the date upon which such termination becomes effective.
- 21.2 The Goods that are complete and ready for shipment within thirty (30) days after the Supplier's receipt of notice of termination shall be accepted by the Procuring agency at the Contract terms and prices. For the remaining Goods, the Procuring agency may elect:
- (a) to have any portion completed and delivered at the Contract terms and prices; and / or
  - (b) To cancel the remainder and pay to the Supplier an agreed amount for partially completed Goods and Services and for materials and parts previously procured by the Suppliers
- 22. Resolution of Disputes** Resolution of dispute shall be through Mechanism for Redressal of Grievances as provided in the rules or through Arbitration Act 1942.
- 23. Governing Language** The Contract shall be written in English language all correspondence and other documents pertaining to the Contract which are exchanged by the parties shall be written in the same language.
- 24. Applicable Law** The Contract shall be interpreted in accordance with the SPP Rules 2010 (amended up to date).

- 25. Taxes and Duties** Supplier shall be entirely responsible for all taxes, duties (including stamp duty), license fees, etc., incurred until delivery of the contracted Goods to the Procuring agency.
- 26. Overriding effect of Sindh Public Procurement Rules 2010 (Amended 2019)** In case of conflict or primacy of interpretation the provisions of SPP Rules 2010 (amended up to date) shall have an overriding effect notwithstanding anything to the contrary contained in these bidding documents



## **Part-IV [Bid Data Sheet]**

The following specific data for the subject procurement to be procured shall complement, supplement, or amend the provisions in the Instructions to Bidders (ITB) Part One. Whenever there is a conflict, the provisions herein shall prevail over those in ITB.

| <b>Introduction</b>                       |   |
|---|---|
| <b>ITB 1</b>                              | <b>Name of Procuring Agency:</b> Sukkur IBA University<br>Tel # 071-564 4142, 071-564 4000 (Ext: 4142), Fax: 071-580 4419   |
| <b>Bid Price and Currency</b>             |   |
| <b>ITB 4</b>                              | Prices quoted by the Bidder shall be <b><i>“fixed” and in” Pak Rupees.”</i></b>   |
| <b>Preparation and Submission of Bids</b> |   |
| <b>ITB 7</b>                              | <p><b>Eligibility / Responsiveness criteria:</b></p> <ol style="list-style-type: none"> <li>1. Bidder should quote price only in PKR. with all applicable taxes, duties, freight, etc. In case the bidder does not mention clearly about the taxes in the bid, it will be treated as a bid, including all applicable taxes, duties, freight</li> <li>2. Bidder should strictly compliant with technical specifications; no optional /Alternative items will not be accepted without bid security. In case without bid security of optional/alternate item, the complete bid shall be rejected.</li> <li>3. Three years’ relevant experience.</li> <li>4. Income Tax Certificate (NTN), GST Registration Certificate</li> <li>5. Professional Tax Certificate</li> <li>6. Details of turnover (Including in terms of Rupees) of at least the last three years. The average annual turnover of three years should be at least equal to or twice the estimated cost of this tender item.</li> <li>7. Affidavit confirming that the firm has not been blacklisted by any Government, Semi Government, or Autonomous Bodies on non-judicialstamp paper.</li> <li>8. Bidder must not have forfeited performance security deposit with Procuring Agency (Sukkur IBA University).</li> <li>9. The words “Or Equivalent” shall not be used for items for which prices are quoted. Bidders must clearly mention brand name and specifications, and using the words “or equivalent” to inexplicit brand name or specifications will leadto ambiguity and will ultimately result in the Rejection of the complete bid.</li> <li>10. Bidder must be manufacturer/ authorized distributor/ authorized dealer of the quoted product.</li> <li>11. Company profile</li> </ol> |
| <b>ITB 9</b>                              | <b>Amount of bid security.</b> 2% of the Bid Value  |
| <b>ITB 10</b>                             | <b>Bid validity period.</b> 90 days   |
| <b>ITB 11</b>                             | <b>Number of copies.</b> One original - - -   |
| <b>ITB 13</b>                             | Deadline for bid submission. As notified in NIT,  |
| <b>ITB 19.1</b>                           | <b>Bid Evaluation:</b> The Most Advantageous Lowest evaluated responsive bid  |

**Other Terms & Conditions:**

- i. In case of any unforeseen situation or government holiday resulting in closure of office on the date of opening. Bid shall be submitted / opened on next working day at the given time
- ii. Tender documents can also be obtained by post against Pay Order/Bank Draft of Rs-800/- as courier charges in addition of tender fee.
- iii. SIBAU may reject all or any bid subject to relevant provision of SPP Rules and may cancel the bidding process at any time prior to acceptance of bid or proposal as per Rule 25(1) of said rules.
- iv. Incomplete, conditional and tender without required earnest money in the specified form/format shall be rejected.
- v. Bidders are advised that before filling the bidding documents all pages of bidding documents should carefully be rechecked. If any page(s) / paper(s) of bidding documents are missing that can be downloaded from the official website of this University and SPPRA, and also can be obtained from the office of the Procurement Department, Sukkur IBA University Main Campus at Nisar Ahmed Siddiqui Road, Sukkur. Bid(s) with incomplete bidding documents will straightaway be rejected.
- vi. Bidders are required to provide their valid e-mail Ids and contact numbers (s) for effective and timely communication
- vii. Affidavit that firm is not blacklisted.
- viii. All Bidding documents must be signed, named & stamped by authorized person of the firm/ Companies along with authorized letter.
- ix. Incomplete, conditional and tender without required bid security as specified in the bidding documents, shall be reject. Each page of bidding documents should be signed and stamped.
- x. Contract Agreement and Integrity Pact both are mandatory for successful bidder.
- xi. Prescribed Sales Tax Invoice, payment of Stamp Duty at rate specified by Government of Sindh, Valid Professional Tax Certificate and Job Completion / Inspection Certificate duly issued by Indenting Department will be required for payment. However, withholding of all government Taxes shall apply as rates specified in relevant Government Schedule.

Signature & Stamp of Tenderer

**Special Conditions of Contract**

The following Special Conditions of Contract shall supplement the General Conditions of Contract. Whenever there is a conflict, the provisions herein shall prevail over those in the General Conditions of Contract. The corresponding clause number of the GCC is indicated in parentheses.

**1. Definitions (GCC Clause 1)**

GCC 1 (g)—The Procuring Agency is: Sukkur IBA University, Sukkur

**2. Performance Security (GCC Clause 4)**

GCC 4—The amount of performance security, as a percentage of the Contract Price, shall be 2%. Performance Security shall be released on recommendations of the indenting Department or after completion of six months, whichever is earlier. The bid security of a successful bidder may be retained as the performance security.

**3. Inspections and Tests (GCC Clause 5)**

Inspection of SIBAU shall inspect the procured good and ensure that it meets the tender specifications before its acceptance

**4. Delivery and Documents (GCC Clause 7)**

GCC 10—Supplier shall supply and install the good within Seven Calendar Days after signing the receipt of purchase order via courier of electronic/ICT means Supplier's invoice showing Goods' description, quantity, unit price, and total amount;

- (i) Packing List identifying the contents of Supply;
- (ii) Delivery note.
- (iii) Warranty and guarantee certificate (if required & mentioned as per Part-VIII)

**5. Warranty (GCC Clause 12)**

The equipment shall bear Standard warranty (with free parts & labor) from the date of installation / acceptance. Upon expiration of warranty, Purchaser at its option may enter into a Service Level Maintenance Agreement upon expiry of the warranty period in accordance with terms embodied in Appendix-A hereto

**6. Payment (GCC Clause 13)**

100% of the Contract Price shall be paid upon 100% delivery after issuance of Inspection Certificate from Indenting Department. Bidder is responsible to get Inspection Certificate from Indenting Department.

**7. Liquidated Damages (GCC Clause 17)**

If the Supplier fails to deliver the goods or perform the services within the time period(s) specified in the contract, the Purchaser shall, without prejudice to its other remedies under the contract deduct from the Contract Price, as liquidated damages, a sum equivalent to 0.1 percent of the Contract Price for each day of delay until actual delivery or performance, up to a maximum deduction of 10% of the Contract Price. Once the maximum is reached, the purchaser may consider termination of the contract.

**8. Resolution of Disputes (GCC Clause 22)**

In the case of a dispute between the Procuring agency and the Supplier, the dispute shall be referred to the dispute resolution mechanism as defined in rule 31, 32 and 34 of the (SPPR 2010) Amended up to date

**9. Applicable Law (GCC Clause 24)**

GCC 24 Contract shall be interpreted in accordance with the Sindh Public Procurement law of Sindh.

**Part-VI**  
**SCHEDULE OF REQUIREMENTS**

The delivery schedule hereafter expressed the date of delivery required.

| <b>S.<br/>No</b> | <b>Items/Quantity</b>  | <b>Delivery time after<br/>issuance of Award of<br/>Work.</b> | <b>Location of<br/>Supply</b> |
|------------------|--|---|-------------------------------|
| 1.               | [As specified in Part – VIII of this bidding documents at P-32]. | Preferably within<br>30 Days                                  | At Site(s)                    |

**Note:** **specifications of above items are attached**

**PART-VII**  
**SAMPLE FORMS**

**Form-I**

**Letter of Acceptance**

Date: \_\_\_\_\_

To:

---

Sukkur IBA University  
Sukkur

Dear Sir:

Having examined the bidding documents, the receipt of which is hereby duly acknowledged, we, the undersigned, offer to supply and deliver the required item in conformity with the said bidding documents for the sum of *[total bid amount in words and figures]* or such other sums as may be ascertained in accordance with the Schedule of Prices attached herewith and made part of this Bid.

We undertake, if our Bid is accepted, to deliver the goods in accordance with the delivery schedule specified in the Schedule of Requirements.

If our Bid is accepted, we will obtain the guarantee of a bank in a sum equivalent to Twp (2) percent of the Contract Price/Pay order for the due performance of the Contract, in the form prescribed by the Purchaser.

We agree to abide by this Bid for a period of 90 days from the date fixed for Bid opening under Clause 10 of the Instructions to Bidders, and it shall remain binding upon us and may be accepted at any time before the expiration of that period.

Until a formal Contract is prepared and executed, this Bid, together with your written acceptance thereof and your notification of award, shall constitute a binding Contract between us.

We understand that you are not bound to accept the lowest or any bid you may receive.

Dated this \_\_\_\_\_ day of \_\_\_\_\_.

\_\_\_\_\_  
*[signature]*

\_\_\_\_\_  
*[in the capacity of]*

Duly authorized to sign Bid for and on behalf of \_\_\_\_\_

**Price Schedule in Pak. Rupees**

Name of Bidder \_\_\_\_\_ . IFB Number \_\_\_\_\_ . Page of \_\_\_\_\_

| 1    | 2           | 3                 | 4        | 5          |        | 6     | 7                |
|------|-------------|-------------------|----------|------------|--------|-------|------------------|
| Item | Description | Country of origin | Quantity | Unit price |        | Total | Remarks (if any) |
|      |             |                   |          | Words      | Figure |       |                  |
|      |             |                   |          |            |        |       |                  |

Total Bid amount in words: \_\_\_\_\_

Total Bid amount in figure: \_\_\_\_\_

Signature of Bidder \_\_\_\_\_

*Note:*

- (i) In case of discrepancy between unit price and total, the unit price shall prevail.
- (ii) The unit and total prices Delivered at Sukkur IBA University, Sukkur should include the price of incidental services. No separate payment shall be made for the incidental services.





**PART-VIII**  
**SPECIFICATIONS AND QUANTITIES**

**Important Notes:**

The brand name (if any) mentioned in the bid documents should be read with the words “or equivalent” after it.

| Item Code No. | Description of Items/Specifications   | Unit      | Price in Pak. Rupees Only |             |                    |                         | Total Amount with GST / SRB  |
|---------------|---|-----------|---------------------------|-------------|--------------------|-------------------------|--|
|               |   |           | Unit Price                |             |                    | Total Quantity Required |  |
|               |   |           | Without GST/SRB           | Add GST/SRB | Total With GST/SRB |                         |  |
| 1             | 2   | 3 = (1+2) | 1                         | 5 = (1x3)   |                    |                         |  |
| 1             | Solar Panels 580 Watts Mono PERC (Ginko/Longi or equivalent)<br>Detailed specifications on next pages | Each      |                           |             |                    | 20                      |  |
| 2             | Galvanized Solar Stand/frame for 10 (580-watt panels)<br>Detailed specifications on next pages        | Structure |                           |             |                    | 1                       |  |
| 3             | Solar DC Wire from Panel to Inverter<br>Detailed specifications on next pages                         | Set       |                           |             |                    | 2                       |  |
| 4             | Necessary Bolts/Pipes for Wires   | Set       |                           |             |                    | 1                       |  |
|               |   |           |                           |             |                    | <b>Total Freight</b>    |  |
|               |   |           |                           |             |                    |                         | <b>Total Bid Amount, including all Provincial and Federal taxes &amp; duties, Freight, etc.,</b> |

Important Notes: Quoted rates must be including freight, installation charges (if any), etc.

Wherever in specifications, brand name is mentioned, please read with the words “or equivalent “after brand name.

Please mention the warranty/guarantee and availability status of the quoted products clearly.

\_\_\_\_\_  
Signature & Stamp of Bidder

# Tiger Neo N-type 72HL4-BDV 560-580 Watt BIFACIAL MODULE WITH DUAL GLASS

## N-Type

Positive power tolerance of 0~+3%

IEC61215(2016), IEC61730(2016)

ISO9001:2015: Quality Management System

ISO14001:2015: Environment Management System

ISO45001:2018

Occupational health and safety management systems

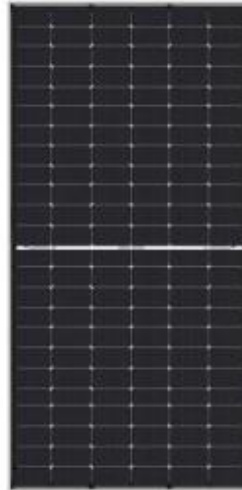

## Key Features



### SMBB Technology

Better light trapping and current collection to improve module power output and reliability.



### Hot 2.0 Technology

The N-type module with Hot 2.0 technology has better reliability and lower LID/LETID.



### PID Resistance

Excellent Anti-PID performance guarantee via optimized mass-production process and materials control.



### Enhanced Mechanical Load

Certified to withstand: wind load (2400 Pascal) and snow load (5400 Pascal).



### Higher Power Output

Module power increases 5-25% generally, bringing significantly lower LCOE and higher IRR.



## LINEAR PERFORMANCE WARRANTY

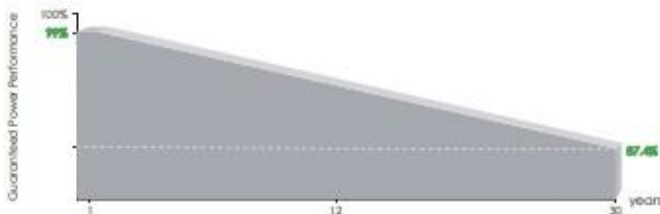

12 Year Product Warranty

30 Year Linear Power Warranty

0.40% Annual Degradation Over 30 years

## Engineering Drawings

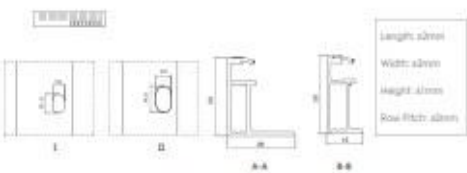
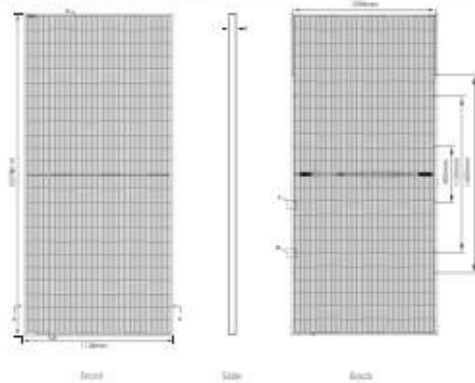

## Packaging Configuration

(Two pallets = One stack.)

36pcs/pallets, 72pcs/stack, 720pcs/ 40HQ Container

## Electrical Performance & Temperature Dependence

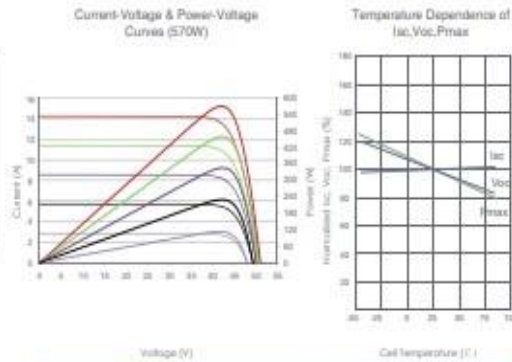

## Mechanical Characteristics

|               |  |
|---------------|--|
| Cell Type     | N type Mono-crystalline                                    |
| No. of cells  | 144 (2*72)   |
| Dimensions    | 2278*1134*30mm (89.69*44.65*1.18 inch)                     |
| Weight        | 32 kg (70.55 lbs)  |
| Front Glass   | 2.0mm, Anti-Reflection Coating                             |
| Back Glass    | 2.0mm, Heat Strengthened Glass                             |
| Frame         | Anodized Aluminum Alloy                                    |
| Junction Box  | IP68 Rated   |
| Output Cables | TUV 1*4.0mm<br>(+): 400mm, (-): 200mm or Customized Length |

## SPECIFICATIONS

| Module Type                               | JKM560H-72HL4-BDV |        | JKM565N-72HL4-BDV |        | JKM570H-72HL4-BDV |        | JKM575N-72HL4-BDV |        | JKM580N-72HL4-BDV |        |
|---|-------------------|--------|-------------------|--------|-------------------|--------|-------------------|--------|-------------------|--------|
|   | STC               | NOCT   | STC               | NOCT   | STC               | NOCT   | STC               | NOCT   | STC               | NOCT   |
| Maximum Power (Pmax)                      | 560Wp             | 421Wp  | 565Wp             | 425Wp  | 570Wp             | 429Wp  | 575Wp             | 432Wp  | 580Wp             | 436Wp  |
| Maximum Power Voltage (Vmp)               | 41.95V            | 39.39V | 42.14V            | 39.52V | 42.29V            | 39.65V | 42.44V            | 39.78V | 42.59V            | 39.87V |
| Maximum Power Current (Imp)               | 13.35A            | 10.69A | 13.41A            | 10.75A | 13.48A            | 10.81A | 13.55A            | 10.87A | 13.62A            | 10.94A |
| Open-circuit Voltage (Voc)                | 50.67V            | 48.13V | 50.87V            | 48.32V | 51.07V            | 48.51V | 51.27V            | 48.70V | 51.47V            | 48.89V |
| Short-circuit Current (Isc)               | 14.13A            | 11.41A | 14.19A            | 11.46A | 14.25A            | 11.50A | 14.31A            | 11.55A | 14.37A            | 11.60A |
| Module Efficiency STC (%)                 | 21.68%            |        | 21.87%            |        | 22.07%            |        | 22.26%            |        | 22.45%            |        |
| Operating Temperature (°C)                | -40°C~+85°C       |        |                   |        |                   |        |                   |        |                   |        |
| Maximum system voltage                    | 1500VDC (IEC)     |        |                   |        |                   |        |                   |        |                   |        |
| Maximum series fuse rating                | 30A               |        |                   |        |                   |        |                   |        |                   |        |
| Power tolerance                           | 0~+3%             |        |                   |        |                   |        |                   |        |                   |        |
| Temperature coefficients of Pmax          | -0.29%/°C         |        |                   |        |                   |        |                   |        |                   |        |
| Temperature coefficients of Voc           | -0.25%/°C         |        |                   |        |                   |        |                   |        |                   |        |
| Temperature coefficients of Isc           | 0.045%/°C         |        |                   |        |                   |        |                   |        |                   |        |
| Nominal operating cell temperature (NOCT) | 45±2°C            |        |                   |        |                   |        |                   |        |                   |        |
| Refer. Bifacial Factor                    | 80±3%             |        |                   |        |                   |        |                   |        |                   |        |

## BIFACIAL OUTPUT-REAR SIDE POWER GAIN

|     |                           | JKM560H-72HL4-BDV |        | JKM565N-72HL4-BDV |        | JKM570H-72HL4-BDV |        | JKM575N-72HL4-BDV |        | JKM580N-72HL4-BDV |        |
|-----|---------------------------|-------------------|--------|-------------------|--------|-------------------|--------|-------------------|--------|-------------------|--------|
|     |                           | 3%                | 15%    | 3%                | 15%    | 3%                | 15%    | 3%                | 15%    | 3%                | 15%    |
| 3%  | Maximum Power (Pmax)      | 588Wp             | 644Wp  | 593Wp             | 650Wp  | 599Wp             | 656Wp  | 604Wp             | 661Wp  | 609Wp             | 667Wp  |
|     | Module Efficiency STC (%) | 22.77%            | 24.93% | 22.97%            | 25.10% | 23.17%            | 25.37% | 23.37%            | 25.60% | 23.57%            | 25.82% |
| 15% | Maximum Power (Pmax)      | 644Wp             | 700Wp  | 650Wp             | 706Wp  | 656Wp             | 713Wp  | 661Wp             | 719Wp  | 667Wp             | 725Wp  |
|     | Module Efficiency STC (%) | 24.93%            | 27.10% | 25.10%            | 27.34% | 25.37%            | 27.58% | 25.60%            | 27.82% | 25.82%            | 28.07% |

STC: Irradiance 1000W/m<sup>2</sup> Cell Temperature 25°C AM=1.5  
 NOCT: Irradiance 800W/m<sup>2</sup> Ambient Temperature 20°C AM=1.5 Wind Speed 1m/s

©2022 Jinko Solar Co., Ltd. All rights reserved.  
 Specifications included in this datasheet are subject to change without notice.

JKM560-580N-72HL4-BDV-F4-EN

## SPECIFICATIONS OF SOLAR DC CABLE

---

### The Characteristics of Solar Cable 10mm

**Application:**

Applied to solar panels for power generation and related components of the wiring, connection, particularly suitable for outdoor. Resistance to sunlight, anti-aging, using the low smoke halogen-free flame retardant materials, higher grade, more safety.

**Standard:**

Adapted to PV systems, 2 Pfg 1169 / 08.2007 and EN 50618:2015.

**Electrical Parameters:**

Voltage Rating : AC 0.6 / 1.0 kV Max. PV - System Voltage : DC up to 2.0 kV possible Max. Permissible Operating Voltage in AC Systems : 0.7 / 1.2 kV Max. Permissible Operating Voltage in DC Systems : 0.9 / 1.8 kV Test Voltage : AC 6 kV / DC 10 kV (15 min.)

**Cable Construction:**

Conductor : Fine Wire Tinned Copper Conductor according to BS EN 60228:2005 cl. 5. Insulation : UV resistant, cross linkable, halogen free, flame retardant compound for core insulation. Core Identification : Red, black or natural Sheath : UV resistant, cross linkable, halogen free, flame retardant compound for Sheath over insulation. Cable Colour : Black or Red

# GALVANIZED STRUCTURE

L2 (2PV) & L3 (3PV)



Customise structure can be designed  
as per the site requirement



# **GALVANIZED STRUCTURE**

## **L2 (2PV)**

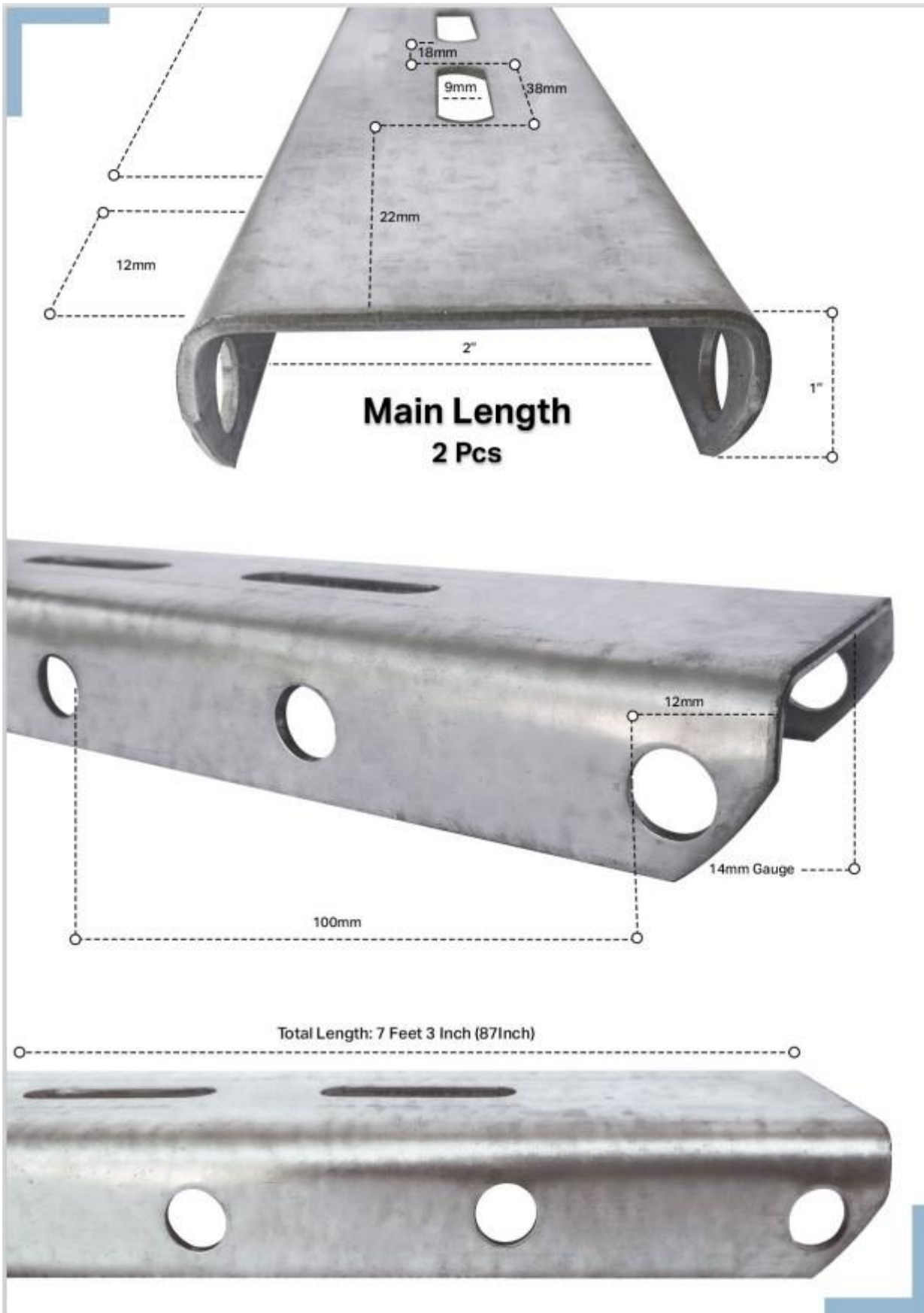





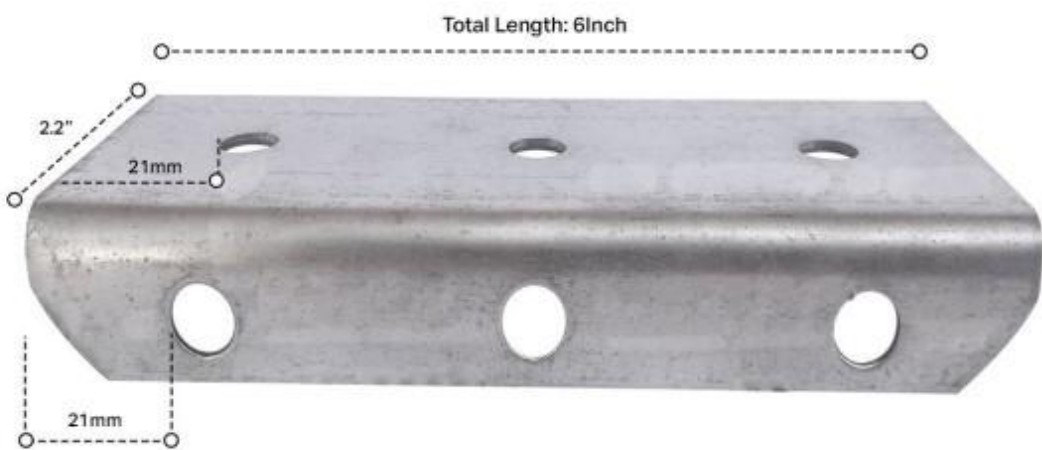
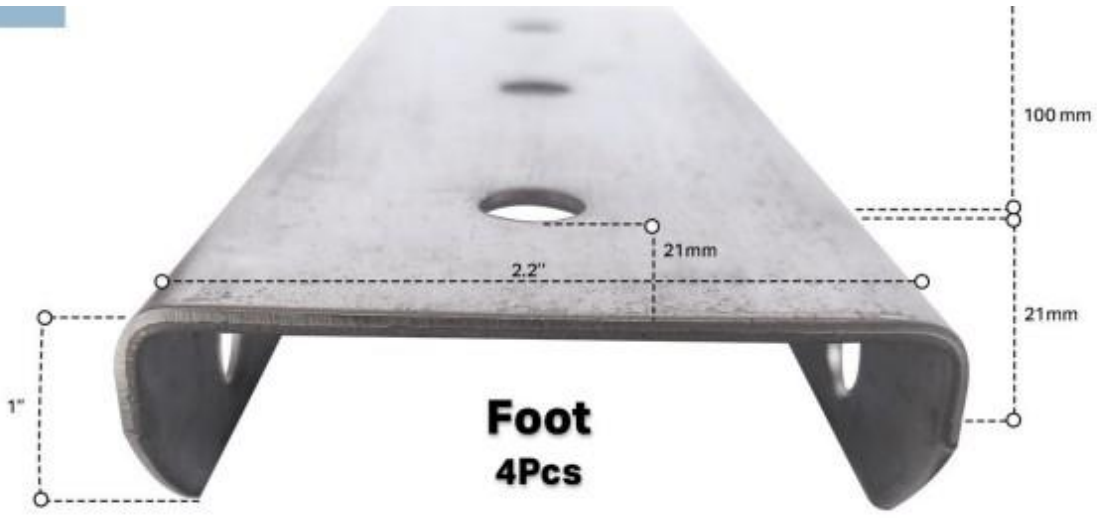

**Iron Rawal Bolts**

2.25 Inch  
6 Pcs



**Iron Nut & Bolts**

3 Inch  
6 Pcs Nut  
6 Pcs Bolt

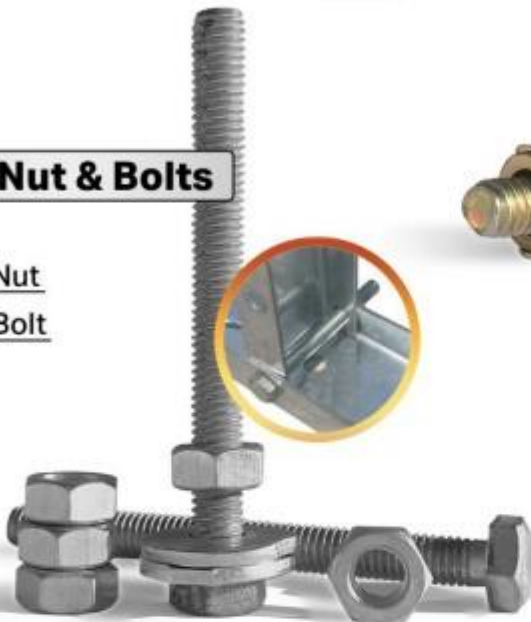

**Iron Nut & Bolts**

1 Inch  
10 Pcs Nut  
10 Pcs Bolt  
20 Pcs Vashal



**Stainles Steel  
Rawal / Nut & Bolts**

Available as per the  
customers requirement



# **GALVANIZED STRUCTURE**

## **L3 (3PV)**









**Iron Rawal Bolts**

2.25 Inch

10 Pcs



**Iron Nut & Bolts**

3 Inch

10 Pcs Nut

10 Pcs Bolt

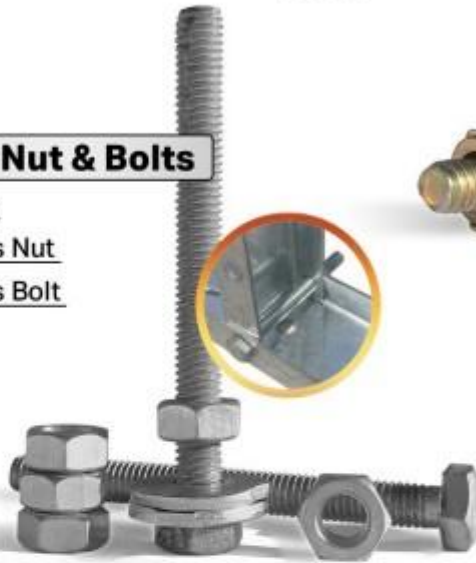

**Iron Nut & Bolts**

1 Inch

16 Pcs Nut

16 Pcs Bolt

32 Pcs Washal



**Stainles Steel  
Rawal / Nut & Bolts**

Available as per the  
customers requirement







## Draft Contract Form

THIS AGREEMENT made the \_\_\_\_\_ day of \_\_\_\_\_ between *Sukkur IBA University, Sukkur* (Hereinafter called “the Procuring agency”) of the one part and *[name of Supplier]* of *[city and country of Supplier]* (hereinafter called “the Supplier”) of the other part:

WHEREAS the Procuring agency invited bids for certain goods and ancillary services, viz., Procurement of \_\_\_\_\_ for \_\_\_\_\_, Sukkur, Sukkur IBA University has accepted a bid by the Supplier for the supply of those goods and services in the sum of *[contract price in words and figures]* (hereinafter called “the Contract Price”).

NOW THIS AGREEMENT WITNESSETH AS FOLLOWS:

4. In this Agreement words and expressions shall have the same meanings as are respectively assigned to them in the Conditions of Contract referred to.
2. The following documents shall be deemed to form and be read and construed as part of this Agreement, viz.:
  - (a) the Bid Form and the Price Schedule submitted by the Bidder;
  - (b) the Schedule of Requirements;  
the Technical Specifications.
  - (d) the General Conditions of Contract;  
the Special Conditions of Contract; and
  - (f) the Procuring agency’s Notification of Award.
3. In consideration of the payments to be made by the Procuring agency to the Supplier as hereinafter mentioned, the Supplier hereby covenants with the Procuring agency to provide the goods and services and to remedy defects therein in conformity in all respects with the provisions of the Contract
5. The Procuring agency hereby covenants to pay the Supplier in consideration of the provision of the goods and services and the remedying of defects therein, the Contract Price or such other sum as may become payable under the provisions of the contract at the times and in the manner prescribed by the contract.

IN WITNESS whereof the parties hereto have caused this Agreement to be executed in accordance with their respective laws the day and year first above written

Signed, sealed, delivered by \_\_\_\_\_ the \_\_\_\_\_ (for the Procuring agency)

Signed, sealed, delivered by \_\_\_\_\_ the \_\_\_\_\_ (for the Supplier)

## Performance Security Form

To:

---

**Sukkur IBA University,  
Sukkur.**

WHEREAS *[name of Supplier]* (hereinafter called “the Supplier”) has undertaken, in pursuance of Contract No. *[reference number of the contract]* dated \_\_\_\_\_ to supply *[description of goods and services]* (hereinafter called “the Contract”).

AND WHEREAS it has been stipulated by you in the said Contract that the Supplier shall furnish you with a bank guarantee by a reputable bank for the sum specified therein as security for compliance with the Supplier’s performance obligations in accordance with the Contract.

AND WHEREAS we have agreed to give the Supplier a guarantee:

THEREFORE, WE hereby affirm that we are Guarantors and responsible to you, on behalf of the Supplier, up to a total of *[amount of the guarantee in words and figures]*, and we undertake to pay you, upon your first written demand declaring the Supplier to be in default under the Contract and without cavil or argument, any sum or sums within the limits of *[amount of guarantee]* as aforesaid, without your needing to prove or to show grounds or reasons for your demand or the sum specified therein.

This guarantee is valid until the \_\_\_\_\_ day of \_\_\_\_\_.

Signature and seal of the Guarantors

---

*[name of bank or financial institution]*

---

*[address]*

---

*[date]*

**Manufacturer's Authorization Form**

To:

---

**Sukkur IBA University,  
Sukkur.**

WHEREAS *[name of the Manufacturer]* who are established and reputable manufacturers of *[name and/or description of the goods]* having factories at *[address of factory]*

do hereby authorize *[name and address of Agent]* to submit a bid, and subsequently sign the Contract with you against NIT No. *[reference of the Invitation to Bid]* for the above goods manufactured by us.

We hereby extend our full guarantee and warranty as per Clause 12 of the General Conditions of Contract for the goods offered for supply by the above firm against this Invitation for Bids.

---

*[signature for and on behalf of Manufacturer]*

*Note:* This letter of authority should be on the letterhead of the Manufacturer and should be signed by a person competent and having the power of attorney to bind the Manufacturer. It should be included

## Integrity Pact

### **DECLARATION OF FEES, COMMISSION AND BROKERAGE ETC. PAYABLE BY THE SUPPLIERS/CONTRACTORS/CONSULTANTS.**

Contract Number: \_\_\_\_\_ Dated: \_\_\_\_\_

Contract Value: \_\_\_\_\_

Contract Title: \_\_\_\_\_

\_\_\_\_\_  
[Name of Supplier/Contractor/Consultant] hereby declares that it has not obtained or induced the procurement of any contract, right, interest, privilege or other obligation or benefit from Government of Sindh (GoS) or any administrative subdivision or agency thereof or any other entity owned or controlled by it (GoS) through any corrupt business practice.

Without limiting the generality of the foregoing, [Name of Supplier/Contractor/Consultant] represents and warrants that it has fully declared the brokerage, commission, fees etc. paid or payable to anyone and not given or agreed to give and shall not give or agree to give to anyone within or outside Pakistan either directly or indirectly through any natural or juridical person, including its affiliate, agent, associate, broker, consultant, director, promoter, shareholder, sponsor or subsidiary, any commission, gratification, bribe, finder's fee or kickback, whether described as consultation fee or otherwise, with the object of obtaining or inducing the procurement of a contract, right, interest, privilege or other obligation or benefit, in whatsoever form, from Procuring Agency (PA), except that which has been expressly declared pursuant hereto.

\_\_\_\_\_  
[Name of Supplier/Contractor/Consultant] certifies that it has made and will make full disclosure of all agreements and arrangements with all persons in respect of or related to the transaction with PA and has not taken any action or will not take any action to circumvent the above declaration, representation or warranty.

\_\_\_\_\_  
[Name of Supplier/Contractor/Consultant] accepts full responsibility and strict liability for making any false declaration, not making full disclosure, misrepresenting facts or taking any action likely to defeat the purpose of this declaration, representation and warranty. It agrees that any contract, right, interest, privilege or other obligation or benefit obtained or procured as aforesaid shall, without prejudice to any other right and remedies available to PA under any law, contract or other instrument, be voidable at the option of PA.

Notwithstanding any rights and remedies exercised by PA in this regard, [Name of Supplier/Contractor/Consultant] agrees to indemnify PA for any loss or damage incurred by it on account of its corrupt business practices and further pay compensation to PA in an amount equivalent to ten times the sum of any commission, gratification, bribe, finder's fee or kickback given by [Name of Supplier/Contractor/Consultant] as aforesaid for the purpose of obtaining or inducing the procurement of any contract, right, interest, privilege or other obligation or benefit, in whatsoever form, from PA.

\_\_\_\_\_  
[Procuring Agency]

\_\_\_\_\_  
[Supplier /Contractor/Consultant]